



Chairborne

Chairborne Machinery Liaoning Co.,

No. 28B, Zone 1, Pacific Industrial City, Shentu New City, Liaoning Province, China



Chairborne

Suppliers of storage and logistics solutions for board materials

About us:

Liaoning Chairborne Mechanical equipment Co., Ltd. is a manufacturer and supplier focusing on the solution of plate material handling and logistics.

Our philosophy is to make the material handling more safe and orderly, and to make the supply chain operation more reliable and efficient



Development and history

In 2020, the company has an area of 8000 square meters, a monthly production capacity of 8000 units, and 20 product R & D engineers.

Import and export business started in 2016

Obtained ISO9001 international quality system certification in 2015

Set up the second factory in 2012

Company founded in 2007

Grack

 Chairborne

Glass rack



- 1** This product is suitable for temporary storage and transportation of board goods, especially fragile goods.
- 2** The product can be stacked up when empty, which is convenient for storage and transportation.
- 3** The product has a hook at four corners, which can be used with lifting equipment.
- 4** This product is equipped with forklift road, which can be used with forklifts or with hand pallet truck.
- 5** This product is equipped with a balance block, which can prevent the backward dumping of cargo fork when lifting, and also balance the position of center of gravity when unloaded.

Applications & Characteristic

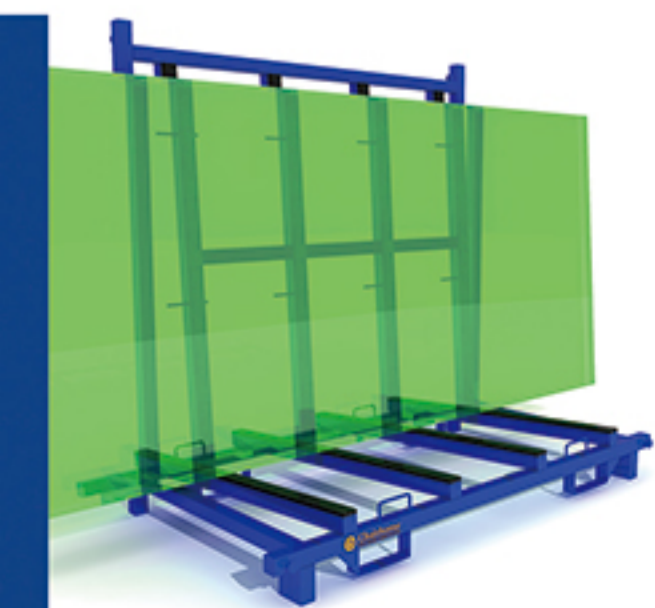



Collapsible Glass Transport Pallet



This steel structure foldable rack is composed of base, the two sides and back. The materials used are all high quality carbon structural steel tube. Generally the specifications of the tube is 50 x 50. Framework and support shall be full penetration in structure, stable structure, carrying capacity is bigger, hold it with glass surface provided in shock absorption, prevent the glass damaged during the transit.

Applications & Characteristic



- 1. Suitable for medium and small size glass, Slate, wood and other fragile goods' transportation and three-dimensional storage.
- 2. Stackable, to improve the utilization of storage space.
- 3. Can be folded when empty, which is convenient for transportation and storage
- 5. Fixed forklift holes to prevent damage to goods caused by improper operation of forklift
- 6. This product can be used together with pallet rack

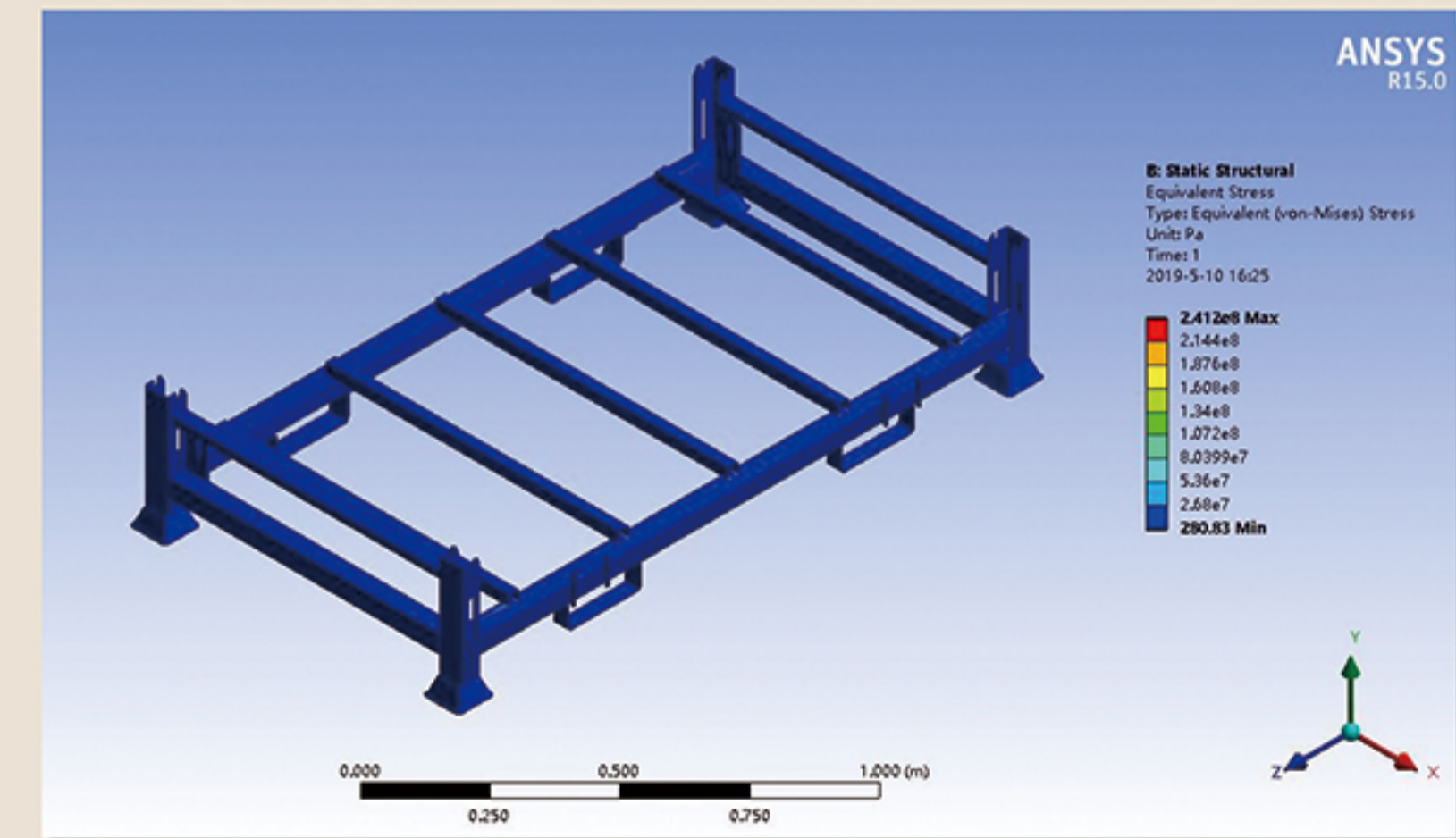



This product is suitable for the temporary storage, transportation and internal transfer of board goods, especially fragile goods.



The product is a combined structure, which can be disassembled and placed when empty, for convenient storage and transportation.



The top beam of this product is provided with a lifting ring, which can be used with lifting equipment.



This product is equipped with forklift road, which can be used with forklifts

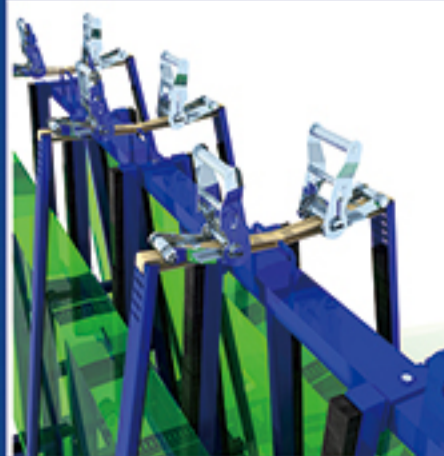

This product is equipped with a limited rod, which can quickly fix the goods and shelves.

Applications & Characteristic



With multiple pull-out storage units, 100% can be pulled out

the upper drawer cooperates with forklift to storage, Assembled vertical type structure, Users can decide if match this drawer according to their own needs

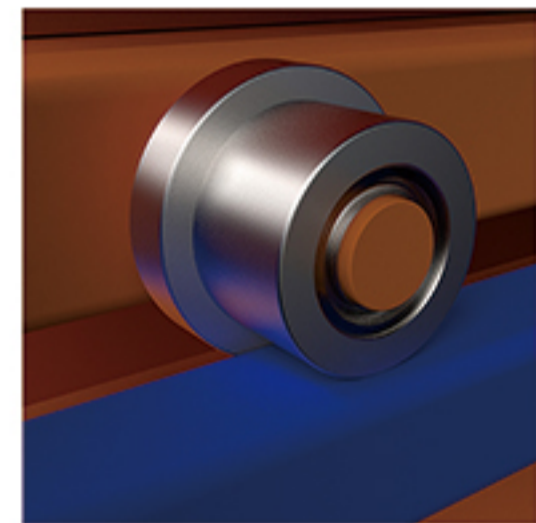
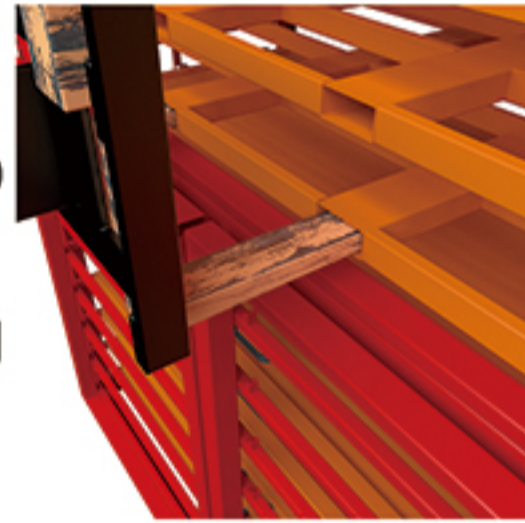

Casters under each drawer can be easily pulled out and pushed back;

BPLARACK

Vertical plate storage rack



Horizontal plate shelf is a new drawer-type shelf structure;The plate material is laid flat on the shelf drawer layer,Each drawer can be pulled 100% fully,Load capacity up to 3 tons,Can store plates material up to more than 10 meters long,- Placing the board flat can keep the board from deforming .And the whole shelf can store many kinds of plate material,Classified and layered management, all plates material are clear at a glance,Access to the goods with cranes, jib cranes or steel clamps,Generally placed near the cutting machine or production equipments, to achieve storage mechanization.

chairborne

BPLARACK



APLARACK



Vertical plate storage rack

The vertical plate shelf adopts the drawer structure design principle. It is mainly composed of two parts, the main frame and the drawer. Each drawer has a space-saving design. The plates are stored upright in a drawer. There are mobile casters at the bottom of each floor. You can easily pull it out, save manpower, improve efficiency, and make access faster and easier.



Applications & Characteristic

1. This product is suitable for storing all kinds of metal, wood, plastic and other plates
2. Casters under each drawer can be easily pulled out and pushed back
3. The main frame is provided with rolling guides to prevent derailment and collision
4. There are multiple pull-out storage units, each unit stores the plates independently to prevent the plates from scratching each other

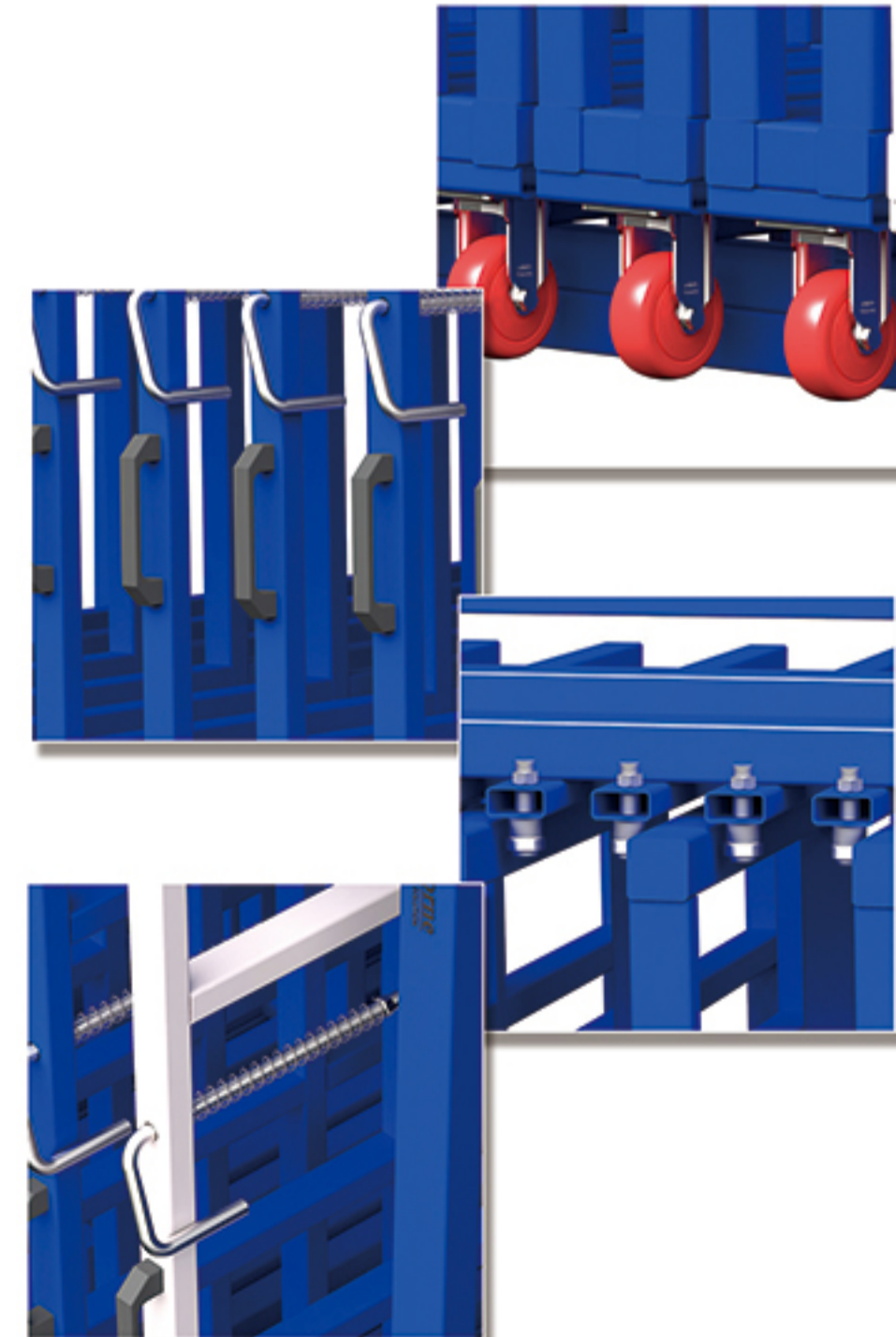



Chairborne Machinery Liaoning Co.,

No. 28B, Zone 1, Pacific Industrial City, Shenfu New City, Liaoning Province, China

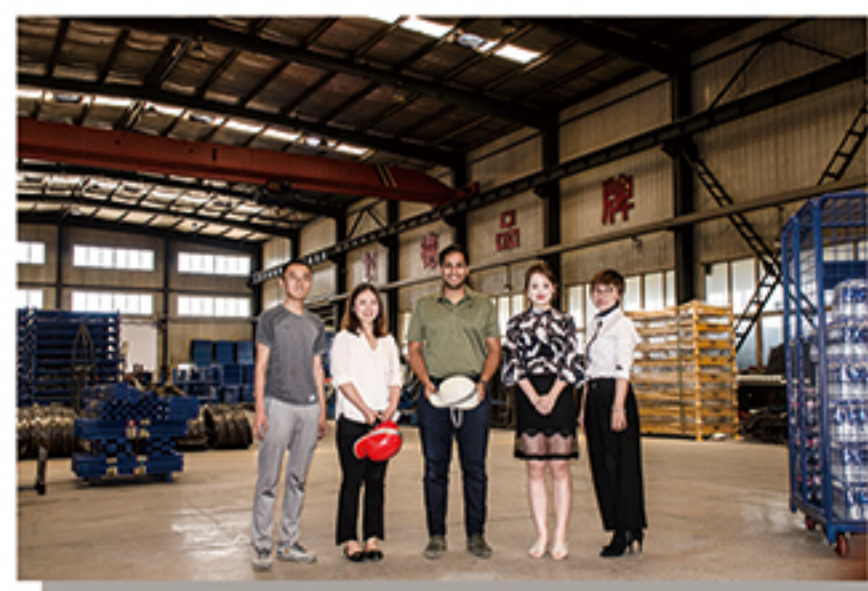

1. Provide pre-sales customer service and product engineer technical support to provide the best solution.
2. If you provide complete usage parameters, 3D technical drawings will be provided free of charge.
3. Support OEM.
4. Provide installation and technical guidance, and train local technicians.
5. Video acceptance before delivery.
6. Agency transportation service.
7. Support Alibaba credit guarantee service to solve the problem of payment trust.
8. Provide product warranty service.